

Intestatrice manuale per profilati in alluminio e pvc, con morsa pneumatica regolabile $\pm 45^\circ$ e cambio rapido manuale del gruppo frese.

Manual end-milling machine for aluminium and pvc profiles, with pneumatic adjustable clamp $\pm 45^\circ$ and manual rapid change of mills group.

Machine à abouter manuelle pour profilés en aluminium et pvc, avec étau pneumatique réglable $\pm 45^\circ$ et changement rapide manuel du groupe fraise.

Manuelle Ausklinkfräsmaschine für Aluminium und Kunststoff Profile, mit pneumatischer ausrichtbarer Spannvorrichtung $\pm 45^\circ$ und manuellem Schnellwechsel des Fräsersatzes.

Retestadora manual para perfiles de aluminio y pvc, con mordaza neumática regulable $\pm 45^\circ$ y cambio rápido manual del conjunto de fresasoras.

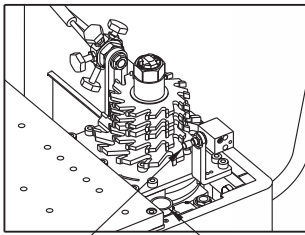

Lubrication
cod.502308

Pneumatic rapid
change tool
cod.502317

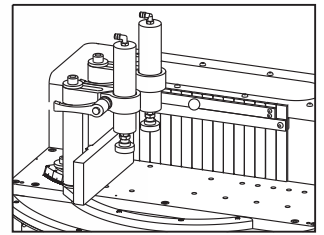
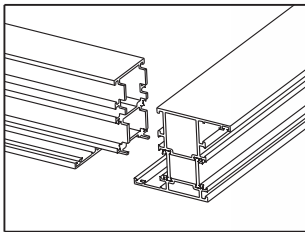

Cod.=100150

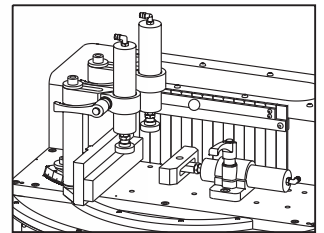

Cod.=100150 + 502321

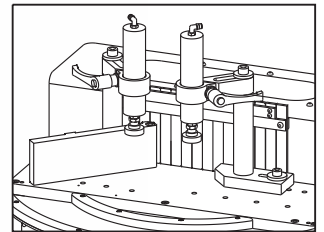

Cod.=100150 + 502212

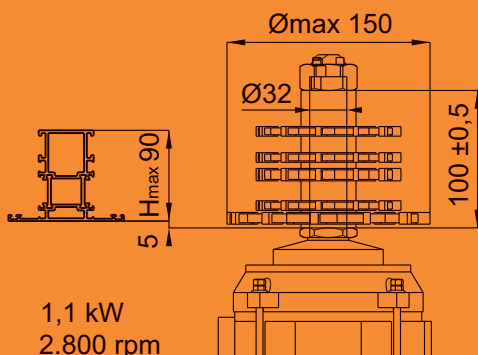

1,1 kW
2.800 rpm



400 Volt



6±8 Bar

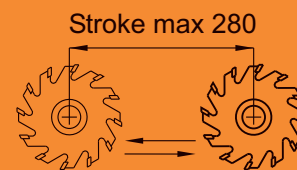

Stroke max 280

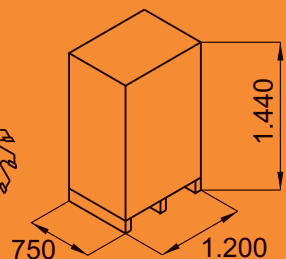

750 1.200 1.440



kg
95